

REVISION RECORD

REV	ECN	DESCRIPTION	DRFT	DATE
-----	-----	-------------	------	------

NOTES1:

UL Standard

- 1.Rated voltage/current : 300V / 8A
- 2.Withstanding voltage : AC1600V/1Min.

IEC Standard

1. Pollution Degree	2
Overvoltage Category	II
Rate Impulse Voltage(KV)	2.5KV
Rate Voltage(V)	250V
Rate Current(A)	7A

NOTES2:

- 1.Dimension shall be interpreted per ASME Y14.5-2009
- 2.Pitch : 3.5/3.81mm, Poles : N=02~22P
- 3.Operating temperature: -40°C~+105°C
- 4.Undimensioned tolerances:

Pitch range in mm		Nominal dimension range in mm				
TO	Over	TO	Over	TO	Over	0.1/10
6	10	30	60	100	150	∠
6	10	30	60	100	150	∠
±0.15	±0.20	±0.30	±0.50	±0.70	±1.00	±2'

5.RoHS Compliance

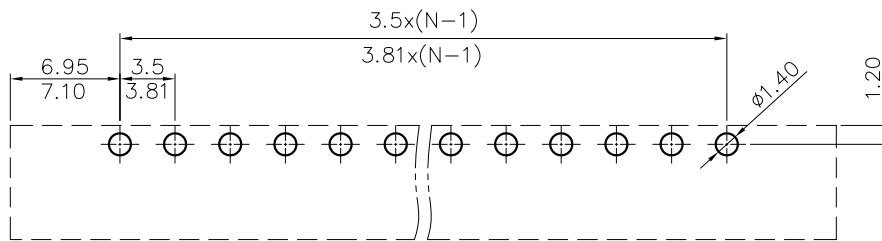
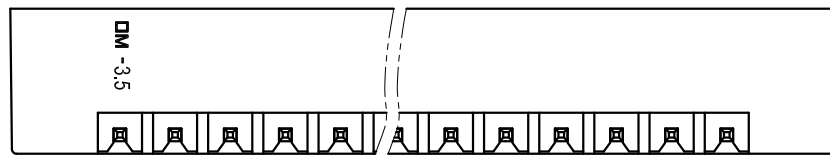
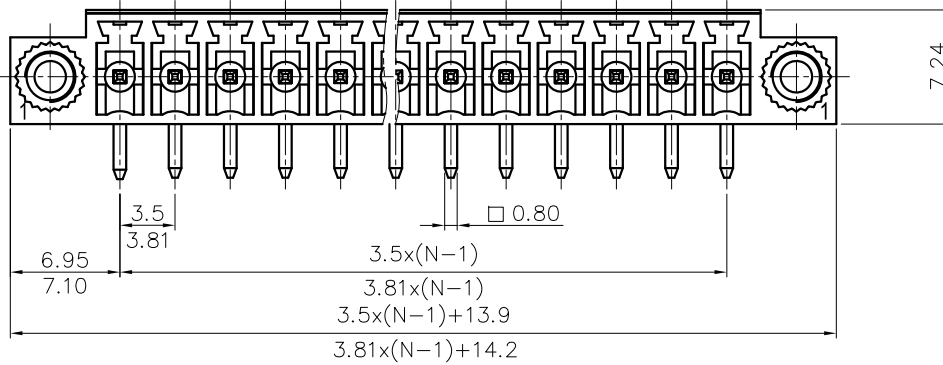
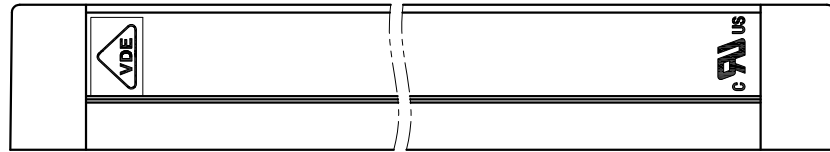
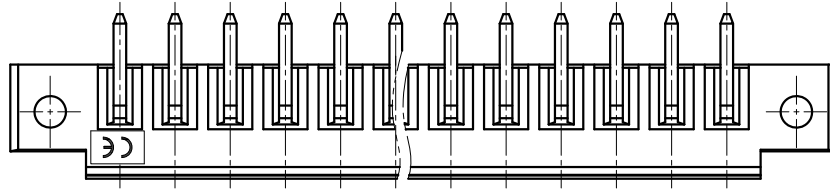
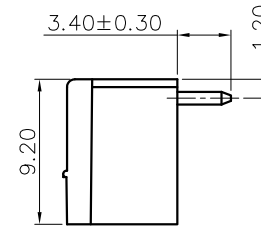

PCB LAYOUT

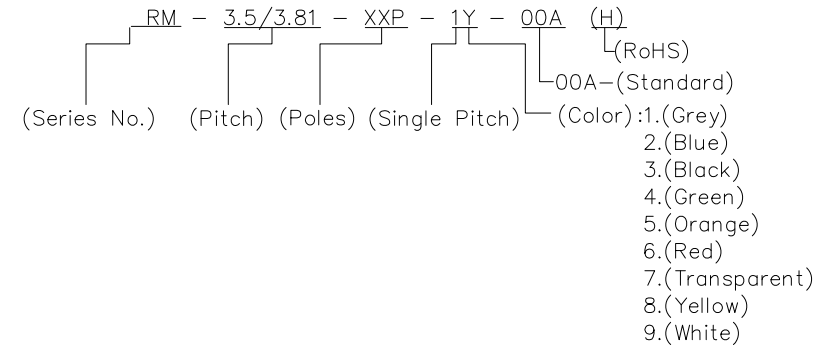

DETACHED LISTS	PART NO.:	AORM-3.5 / 3.81		
	APPD:	NAME: RM-3.5/3.81-XXP-1Y-00A(H)		
	CHKD:	TITLE: CUSTOMER DRAWING		
	DRFT:	REV	DO	
DRAWING NO.:		SHEET	1/1	
THIRD ANGLE PROJECTION		SCALE	1:1	
MM (INCH)		DO NOT SCALE DRAWING		